

# Regenerative braking feedback energy recovery analysis based on MATLAB/SIMULINK software

ZHUAN YOU<sup>1</sup>

**Abstract.** To improve the energy recovery rate of regenerative braking of electric bus, a coordinated control strategy of electrically hydraulic powered steering (EHPS) of electromagnetic energy feeding is proposed for pure electric power bus driven by rear wheel. When the vehicle starts braking, an electronic processor in braking obtains the braking signal to promote the braking hydraulic pressure to increase the production of the required braking force, and the electronic processor in the braking energy feedback power generation also obtains the signal of the braking energy recovery. The brake control system is combined with the motor control system to determine the braking recovery torque on the electric bus and the respective hydraulic braking force of the front and rear wheels to ensure the balance. Finally, the control strategy is modeled and simulated by using Matlab / Simulink software in combination with the actual working conditions, and the simulation results show the effectiveness of the strategy.

**Key words.** Electric bus, Regenerative braking, EHPS system, Coordinated control.

## 1. Introduction

With the rapid development of science and technology, automotive technology is also constantly improved, and at the same time, the fossil fuel energy on the earth is also gradually depleted. Thus, we are eager to have a kind of new energy vehicle which can take the place of the traditional fossil fuel vehicles, in which the electric buses are considered an optimal choice. However, it is difficult to put the pure electric bus into the market due to shortcomings of endurance mileage, and people think that the best way is to use braking energy feedback power generation technology. It is believed that if the braking energy recovery system is mature, the travel distance of pure electric bus will increase by 10% to 25%. Thus, the braking energy feedback power generation technology is very promising.

---

<sup>1</sup>Department of Automobile Engineering, Huaian Vocational College of Information Technology, Huaian, Jiangsu 223003, China

The research on braking energy feedback generation technology for electric bus in foreign countries is dominated by the combination of the fuel battery, accumulator battery and the braking energy recovery system by taking advantage of the battery to absorb the feedback energy. The role of the braking energy feedback power generation system is to reduce the kinetic energy lost in braking by recovering the electric energy to be stored in the battery when the vehicle is braking, and this process is the braking energy feedback power generation. This kind of braking energy feedback power generation technology takes the fuel cell as the main energy source and relies on the battery as the energy storage device to recover the energy as the auxiliary energy, which has many advantages and is promising. However, this technology is still not mature at present, which is required to be developed in the long term. In 2000, the Pasteur Merieux in the United States developed a super capacitor which is almost applied in all electric buses on sale in the market today and has good performance. Pasteur Merieux has made a considerable profit relying on it, thus, they introduced an improvement plan for the super capacitor used in the electric bus for the purpose of promoting the super capacitor to reach the power density of  $2000 \text{ W / kg}$  and energy density of  $20 \text{ Wh / kg}$ . Although people attach much importance to braking energy feedback power generation technology in the technology development of electric bus, most of them only consider the driving conditions of vehicles in the city during the design of the system, namely the frequent braking and start or acceleration. The idea is also to realize the recovery of braking energy by combining a variety of super capacitors, battery and other relevant devices to convert the energy into electrical energy stored in the super capacitor and finally recovered to the battery. However, there is hardly any research on braking energy feedback power generation technology applicable to other working conditions. In general, vehicles do need to often brake and start in the urban driving conditions, so effective recovery of braking energy can increase the endurance capacity of electric bus by 10% to 25%. For example, mature braking energy feedback power generation technology is used in the Focus Electric Bus made in Ford Motor Company in the United States and the Instant Electric Bus made in Honda (the two vehicles are famous), and the braking energy feedback power generation system of the Focus Electric Bus can increase the endurance mileage by about 20% while that of the Instant Electric Bus can increase the endurance mileage by about 25%. At present, the research on the braking energy recovery system is still in the experimental stage, those on the braking energy feedback power generation technology is mostly in the theoretical analysis and verification stage, and only the individual laboratory builds models to research the realization of braking energy recovery function with the use of super capacitors.

This paper studies the coordinated control strategy of electrically hydraulic powered steering (EHPS) of electromagnetic energy feeding for electric bus, which first shows that more and more attention is paid to the braking energy feedback power generation technology with the development of the science and technology and introduces the research and development status of braking energy feedback power generation and hydraulic control system for pure electric bus at home and abroad; then this paper shows the functions and principles of and analysis on braking en-

ergy feedback power generation and hydraulic control system for pure electric bus; afterwards, we work out the whole algorithm framework of braking energy feedback power generation and hydraulic control system.

## 2. Principles of braking energy feedback power generation and hydraulic braking control system for pure electric bus

### 2.1. Principle of energy feedback power generation EHPS system

The principle of braking energy feedback power generation is shown in Fig.1.

In simple terms, since the battery voltage is much higher than the voltage emitted by the braking energy feedback power generation system, we need to use a special control system to successfully charge the excess energy into the battery, so that the motor can successfully generate power with the braking energy. From Fig. 1, we can understand the principle of regenerative braking of braking energy feedback. The figure includes the resistance  $R_c$ , braking current limiting resistor  $R_B$ , battery voltage  $U$ , motor's induced potential  $E$ , motor armature inductance  $L$ . During the power generation, drive current of motor armature is disconnected and a switch circuit is installed at the right end of the armature. As the motor speed changes constantly, the potential and current are also changing over time, with a relational expression of  $di/dt$  as follows:

$$E = -L \frac{di}{dt}.$$

When the switch is closed, the induced current forms a loop in the role of the induced potential through the switch  $K$ , the braking current and induced current are  $i_1$ , with the following variable relationship:

$$i_1 = -E/(R_B + R_C).$$

When we turn off the switch, the value of  $di/dt$  will rise rapidly, making the induced potential continues to grow until  $E > U$ , so as to realize the effect of energy feedback. If the equivalent resistance is  $R_D$  in the feedback circuit diagram, then the feedback current and braking current will be  $i_2$ , namely:

$$i_2 = (E - U)/(R_c + R_D).$$

The excess energy in braking will be stored in the battery.

### 2.2. Functions and structures of braking energy feedback power generation and hydraulic braking system

The braking energy feedback power generation system refers to a system that converts some kinetic energy lost in the checking brake of vehicle into the electrical energy through the motor and stores it in the premise of ensuring the size of the braking force and safety braking distance. Braking energy feedback power generation

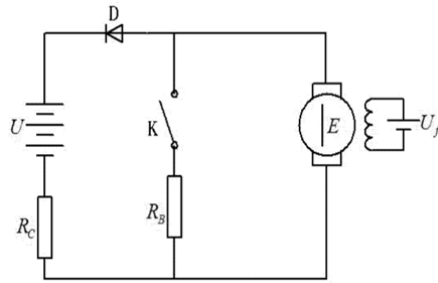

Fig. 1. Circuit diagram of braking energy feedback power generation

technology can convert 30-50% of the kinetic energy output of the electric vehicle into inertial energy, however, only 15-18% of them can be stored after they are actual converted into the electric energy to greatly increase the endurance mileage of electric bus as some of them are lost in the conversion. Thus, it is necessary technology for popularity and marketization of electric bus.

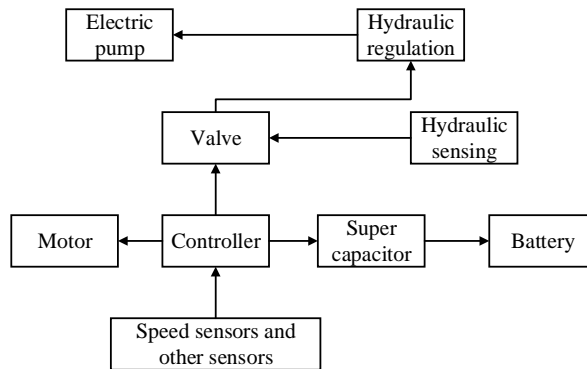

Fig. 2. Braking energy feedback power generation and hydraulic braking system for pure electric bus

The composition of the braking energy feedback power generation and hydraulic braking system is shown in Fig.2. Braking energy feedback power generation and hydraulic braking system generally includes the motor braking subsystem and the hydraulic braking subsystem, which mainly consists of motor, controller, electric pump, hydraulic regulator, battery, super capacitor and various sensors and other devices. In the vehicle braking, the motor feedback braking force is preferred in the premise of ensuring adequate braking torque, and the hydraulic braking force will be supplemented when the feedback braking force can not provide sufficient braking torque. In most cases, the braking energy feedback power generation system and hydraulic braking system are known collectively as the braking energy feedback power generation and hydraulic braking system as they support each other.

Many factors shall be taken into account during the use of energy recovered by the system, such as motion status of motor, battery status and braking stability, and the braking force recovered from the braking process is always changing as the different

status of various parts of electric bus, so we must be able to accurately and quickly adjust the hydraulic braking force so that the total braking force is in line with that required in the vehicle running. As the traditional hydraulic braking system can not meet the requirements of braking energy recovery technology, it is necessary to transform it or design a new hydraulic braking system and its corresponding control strategy, so that the size of the braking force is sufficient to maintain a safe braking distance while increasing the endurance mileage of electric bus.

### ***2.3. Working process of braking energy feedback power generation and hydraulic braking system***

The braking energy feedback power generation and hydraulic braking system will be started when the vehicle slows down, lifts the accelerator pedal or depress the brake pedal for deceleration. The specific working mode has the following three kinds:

(1) To ensure sufficient braking force and a small braking distance, the hydraulic braking shall play a main role and braking energy feedback power generation system only plays a supporting role when the brake deceleration is large. In the emergency braking of vehicle, the hydraulic braking system on the vehicle may provide braking force according to the initial speed.

(2) The braking process of vehicle in the normal working condition for deceleration and stopping can be divided into deceleration process and stopping process. The braking energy feedback power generation system is responsible for the deceleration process, and the stopping process is performed by the hydraulic braking system.

(3) While the electric bus is downhill for a long time, the braking mode of pure braking energy feedback power generation can be used to meet the braking needs since not many braking forces are required.

The braking energy feedback power generation system can be applied to the last two cases as mentioned above. In fact, the basic function of the braking energy feedback power generation for pure electric bus is the mutual conversion between kinetic energy and electric energy through motor. Excellent performance is required for a motor as the motor in the braking energy feedback power generation system for electric bus is used as a generator and a motor and the two working modes are switched frequently. Thus, the motors with switch magnet group or permanent magnet brushless motors are commonly used in the electric buses. The working process is divided into two processes: in the normal running process of electric bus, the motor works as an electric motor to convert the electric energy in the battery into the kinetic energy to drive the vehicle forward; in the braking deceleration of electric bus, the motor works as a generator to convert the current kinetic energy of vehicle into the electric energy to reduce the kinetic energy of vehicle for the purpose of vehicle braking, and at the same time, the converted electric energy is transferred into the super capacitor for temporary storage and then the electric energy will be charged into the battery or transferred into the motor to be converted into the kinetic energy according to the current motion status of vehicle. In this way, the energy consumption from vehicle braking can be greatly reduced.

The braking energy feedback power generation and hydraulic braking system will

be started when the vehicle slows down, lifts the accelerator pedal or depress the brake pedal for deceleration. The driving motor generally works at the maximum power while the electric bus runs at a high speed, at this time, the motor torque is inversely proportional to the speed of the electric bus or the driving motor. Thus, higher speed generated from the energy provided by the motor, less braking energy recovered by the braking energy recovery system in the state of constant power. When the electric bus runs at a low speed, the kinetic energy of the electric bus is not enough to provide the driving motor with energy to produce the maximum braking torque, so the recovery braking effect of the braking energy recovery system is decreased with the reduction of the vehicle speed. Only when the braking torque output by the braking energy recovery system is too small to meet the braking requirements, the hydraulic braking system will be started to ensure adequate braking force.

In general, the braking energy feedback power generation and hydraulic braking system for the electric bus meets four requirements: first, to ensure the comfort in the vehicle running, it is necessary to adjust the hydraulic braking torque based on the size of the braking energy recovery torque so that the vehicle can obtain the required total torque to promote the vehicle to run smoothly. Second, braking force shall be proportionally distributed to front and rear wheels of the electric bus according to the needs to ensure the safety in vehicle braking and prevent the occurrence of side slip, jitter and other unfavorable phenomenon. Third, in order to ensure the lateral stability of vehicles, the maximum braking force applied to the front and rear wheels shall not exceed the maximum allowable value. Fourth, there are many differences between the pure electric buses and traditional vehicles, in which the most significant one is that the engine is replaced by the generator, and the hydraulic pump matching to the engine become unable, so the electric pump matching to the generator is required to increase the hydraulic pressure, so as to change the output torque of the hydraulic braking system. Fifth, in order to improve the reliability of the braking energy feedback power generation and hydraulic braking system for the electric bus, the device to prevent the braking failure is required for braking system of the electric bus, so the double-line braking is adopted in the system to ensure safety.

#### ***2.4. Allocation strategy of braking force EHPS***

In the electric bus, the braking force is provided by the motor and the traditional mechanical brake system. The only motor braking force is not enough, which shall be combined with the mechanical braking force for rational allocation of required braking force based on the running condition of the vehicle. Only in this way, can the economy of vehicles be improved in the premise of ensuring the safety.

The existing braking force allocation strategy can be divided into three types: the optimal braking efficiency control strategy, the optimal economic control strategy and parallel control strategy. The goal of the optimal braking efficiency control strategy is to maximize the recovery of regenerative braking energy in the case of maximizing the braking efficiency of the vehicle; the goal of the optimal economic

control strategy is to maximize the recovery of braking energy; the parallel control strategy is a combination of the above two strategies, of which goal is to ensure the stability of vehicle braking and to maximize the economy [3].

The above three control strategies are three allocation methods of braking force, and the specific control strategy making and parameter selection shall be based on the actual vehicle status. After determining the control strategy, the braking force allocation shall be completed with table look-up. Vehicle control unit collects vehicle speed, brake pedal and other signal to obtain the allocation proportion of motor braking force and mechanical braking force with table look-up, and then the data is transmitted to motor management system and braking management system respectively so that motor and mechanical braking system can complete the braking process. Fig. 1 shows Advisor’s braking force allocation scheme:

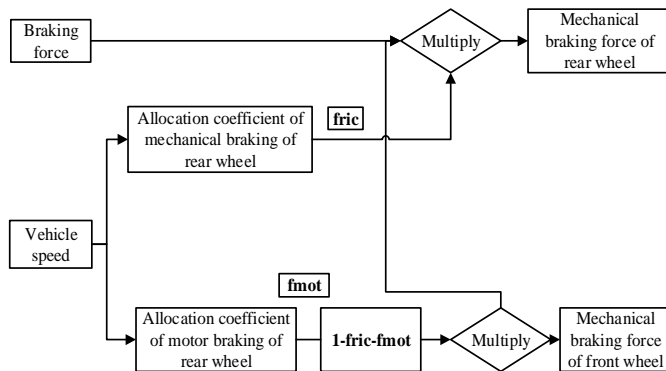

Fig. 3. Advisor braking force allocation scheme

### 3. Experiment analysis

Advisor provides a simple allocation scheme of braking force. This scheme is simple and clear but has many shortcomings, too. It is very complex for braking process of electric bus, and impact of vehicle speed shall be taken into account for braking force allocation, more importantly, the brake strength and the impact of battery SOC shall be considered. It is monotonous and fixed for the braking force allocation under this scheme, with some differences from actual status. In Reference 8, the braking force allocation is completed based on the braking force allocation proportion obtained by table look-up of braking deceleration, in which no vehicle speed and battery status were considered, too. Thus, it is limited.

According to the automobile theory, a whole vehicle model can be established to simulate the regenerative braking strategy in the Matlab / Simulink by combining the battery model. The braking force allocation and energy feedback model is shown in Fig. 4:

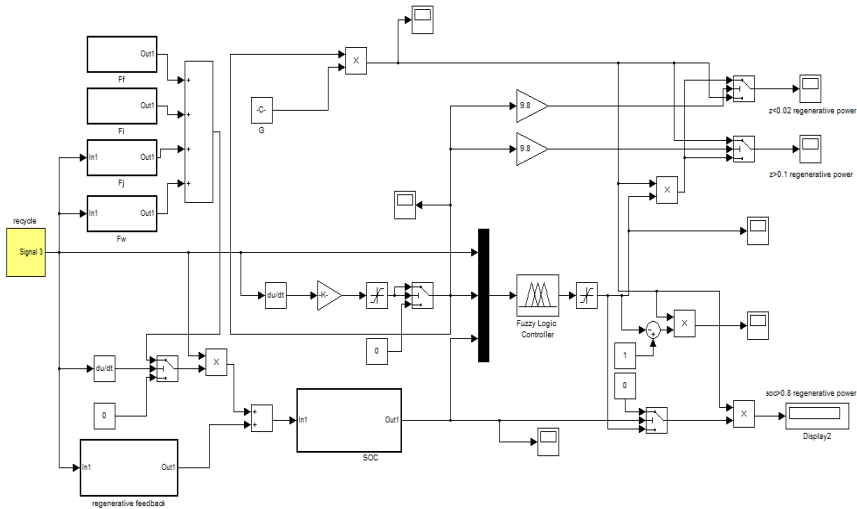

Fig. 4. Regenerative braking force allocation and energy feedback model

We can obtain the surface plot showing that the motor braking ratio responds to change in any two inputs, as shown in Fig. 5:

It can be seen that the regenerative braking ratio increases with the rise of vehicle speed when the battery SOC is constant (less than 0.8) and is maintained at the maximum value keeping constant when the vehicle speed increases a limit value to ensure that the motor works within the rated power as the motor power is limited. Thus, when battery SOC is more than 0.8, the regenerative braking ratio shall be reduced to protect the battery even if the vehicle speed is large. These settings are in line with the requirements of the actual working conditions.

Electric bus runs in the city, so the braking strategy is simulated in the ECE working conditions to obtain the following results:

From the above figure we can see that SOC value picks up significantly in the event that there is a braking energy feedback. The vehicle discharges in the first 23 seconds, and the SOC drops in the two cases are the same, with completely coincident curve; from the 24th second, the vehicle starts to brake, with energy feedback. SOC decreased by 0.0044 in a driving cycle when there is no energy feedback but by 0.0037 in the event that there is a braking energy feedback. It can be seen that the strategy controlling the braking energy feedback for pure electric power bus is effective.

### 4. Conclusion

In this paper, a braking force allocation and braking energy feedback control strategy based on braking energy feedback power generation and hydraulic EHPS braking system is proposed for the pure electric power bus driven by rear wheel, in which the brake control system is combined with the motor control system to determine the braking recovery torque on the electric bus and the respective hydraulic braking force of the front and rear wheels to ensure the balance, and the experimen-



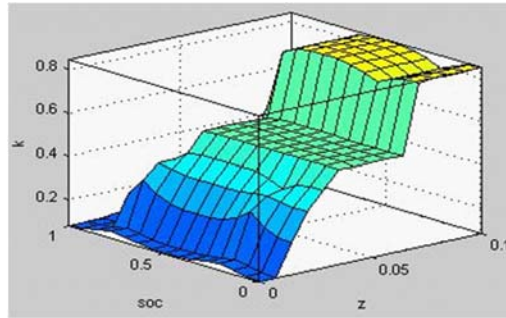

(a) Change of motor braking ratio with the change in SOC and brake strength

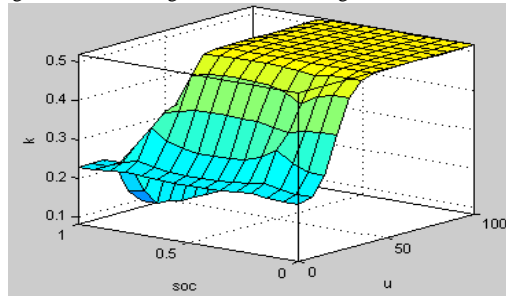

(b) Change of motor braking ratio with the change in SOC and vehicle speed

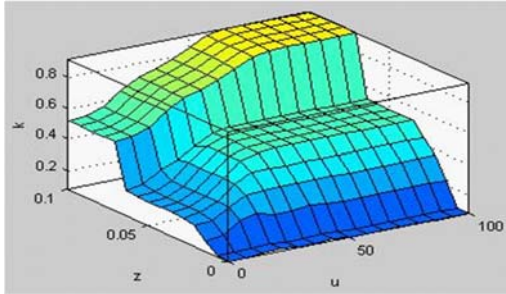

(c) Change of motor braking ratio with the change in brake strength and vehicle speed

Fig. 5. Impact of SOC and brake strength

tal results verified the effectiveness of the proposed algorithm. The shortcoming of the proposed algorithm is that it can be realized only in the laboratory conditions, and future direction is to research how to apply it into a real system to verify the control effect of the algorithm.

### Acknowledgement

Jiangsu University “Blue Project” funded by the project plan, the scientific research foundation of Huai’an College of Information Technology (KA170801).

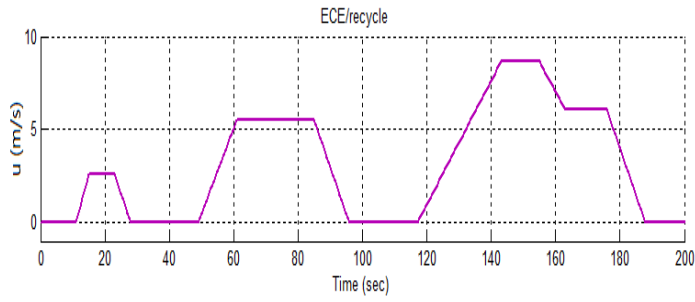

(a) Driving cycle

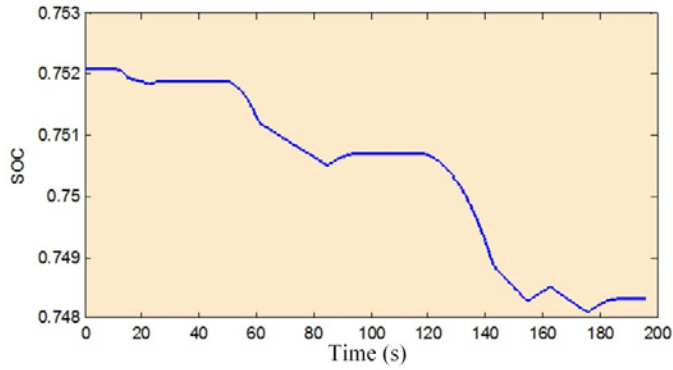

(b) SOC change

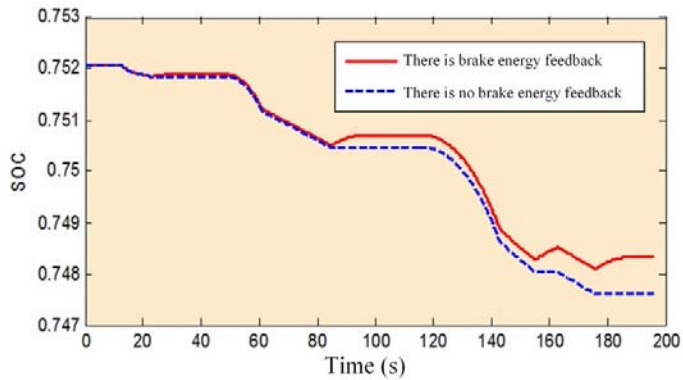

(c) SOC change comparison

Fig. 6. Experimental results

## References

- [1] Y. Y. ZHANG, Q. LI, W. J. WELSH, P. V. MOGHE, AND K. E. UHRICH: *Micellar and Structural Stability of Nanoscale Amphiphilic Polymers: Implications for Anti-atherosclerotic Bioactivity*, *Biomaterials*, 84 (2016), 230–240.
- [2] J. W. CHAN, Y. Y. ZHANG, AND K. E. UHRICH: *Amphiphilic Macromolecule Self-Assembled Monolayers Suppress Smooth Muscle Cell Proliferation*, *Bioconjugate Chemistry*, 26 (2015), No. 7, 1359–1369.

- [3] Y. Y. ZHANG, E. MINTZER, AND K. E. UHRICH: (2016) *Synthesis and Characterization of PEGylated Bolaamphiphiles with Enhanced Retention in Liposomes*, Journal of Colloid and Interface Science, 482, 19-26.
- [4] Y. Y. ZHANG, A. ALGBURI, N. WANG, V. KHOLODOVYCH, D. O. OH, M. CHIKINDAS, AND K. E. UHRICH: *Self-assembled Cationic Amphiphiles as Antimicrobial Peptides Mimics: Role of Hydrophobicity, Linkage Type, and Assembly State*, Nanomedicine: Nanotechnology, Biology and Medicine, 13 (2017), No. 2, 343–352.
- [5] J. J. FAIG, A. MORETTI, L. B. JOSEPH, Y. Y. ZHANG, M. J. NOVA, K. SMITH, AND K. E. UHRICH : *Biodegradable Kojic Acid-Based Polymers: Controlled Delivery of Bioactives for Melanogenesis Inhibition*, Biomacromolecules, 18(2017), No. 2, 363–373.
- [6] B. TANG, H. JIANG, Z. XU Z., ET AL.: *Dynamics of electromagnetic slip coupling for hydraulic power steering application and its energy-saving characteristics*[J]. Journal of Central South University, 22 (2015), No. 5, 1994–2000.
- [7] K. Y. CHO, H. W. KIM, Y. H. CHO: *Review of BLAC Motor and Drive Technology for Electric Power Steering of Vehicles*[J]. Journal of the Korea Academia-Industrial cooperation Society, 12 (2011) No. 9, 4083–4094.
- [8] L. L. MONTEALEGRE: *First Simulink Benchmark for Off-Line and Real-Time Simulation of More-Electric Aircraft (MEA) Electrical Power System*[D]. École Polytechnique de Montréal. (2011).
- [9] A. H. EL-SHAER: *Robust control design of electric power steering systems*[D]. University of California, Berkeley. (2008)
- [10] W. ZHAO: *A power distribution system built for a variety of unattended electronics*[D]. University of Maryland, College Park. (2013).

Received May 7, 2017

